

Valve Control

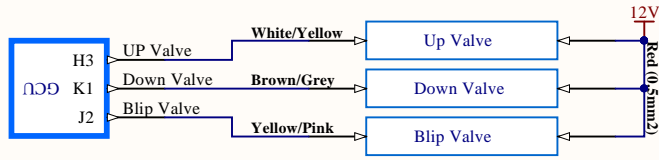

RPM

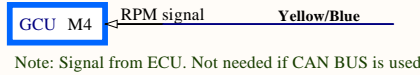

Clutch Control

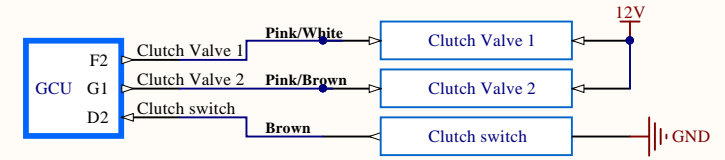

Paddles / Buttons

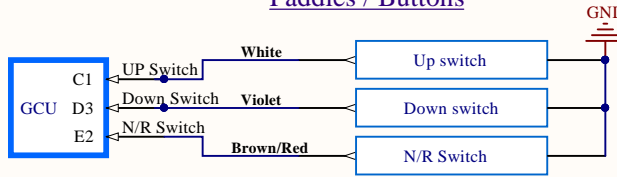

Ignition cut

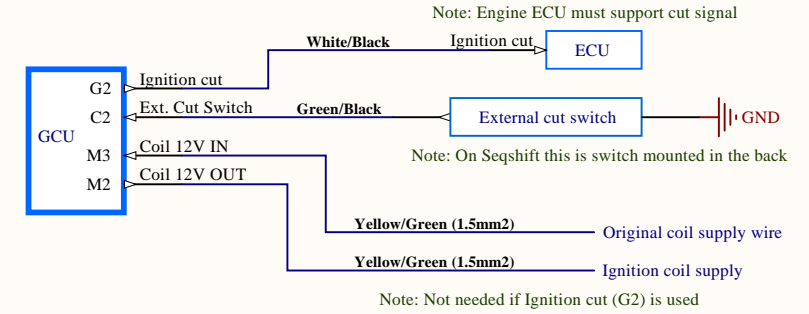

Sensors

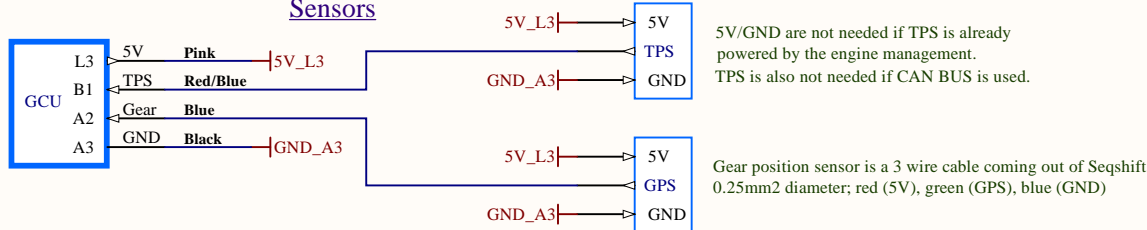

Air Compressor / Bottle

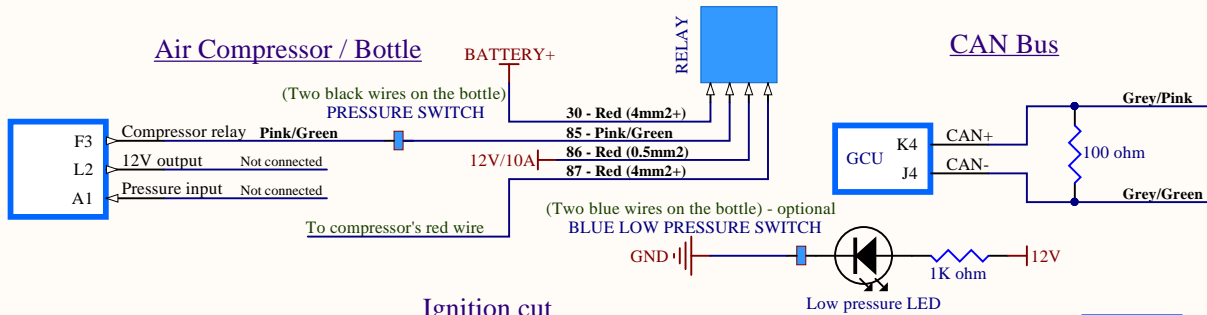

CAN Bus

Auto shifting

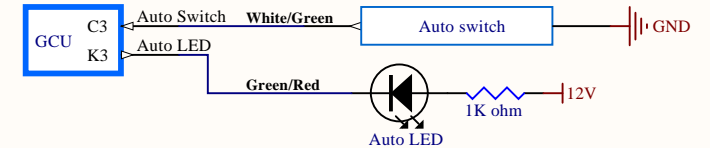

Ignition cut

GCU Power

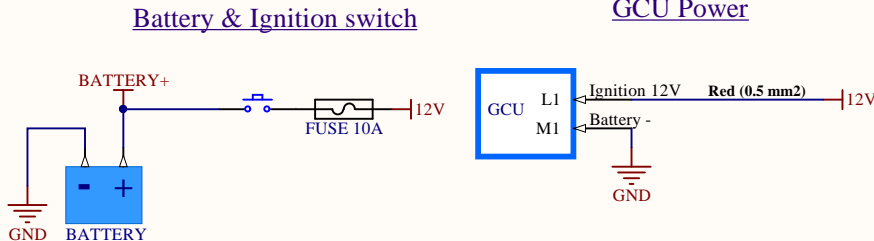

Gear display / Shift light

